

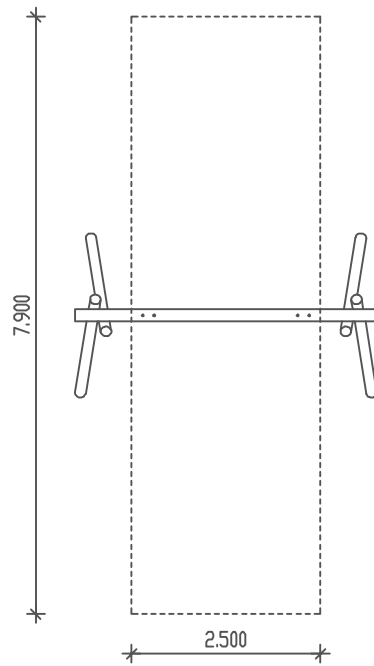

**PIEPER**  
HOLZ

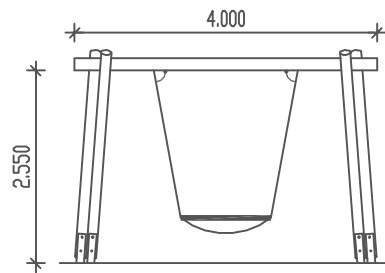

*Nestschaukel*  
Best. Nr.: 11-005 + 11-008

M 1 : 100