

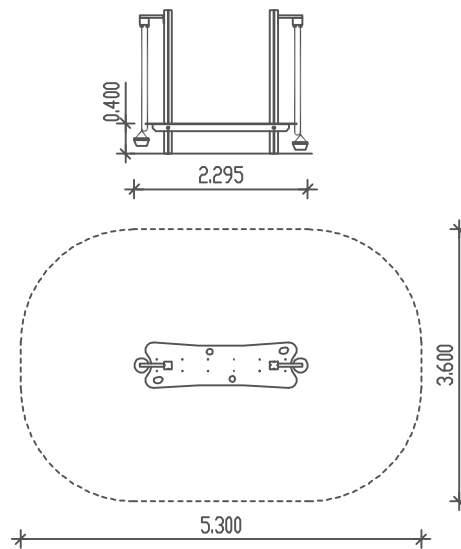

**PIEPER**  
HOLZ



*Sandspieltisch 3*  
Best. Nr.: 33-017

M 1 : 100